

KENWOOD

KDC-PS909

CD-TUNER

INSTRUCTION MANUAL

COMBINÉ TUNER CD

MODE D'EMPLOI

REPRODUCTOR DE DISCOS COMPACTOS

MANUAL DE INSTRUCCIONES

KENWOOD CORPORATION

Take the time to read through this instruction manual.

Familiarity with installation and operation procedures will help you obtain the best performance from your new CD-tuner.

For your records

Record the serial number, found on the back of the unit, in the spaces designated on the warranty card, and in the space provided below. Refer to the model and serial numbers whenever you call upon your KENWOOD dealer for information or service on the product.

Model KDC-PS909 Serial number _____

©B64-1223-00 (KW)



Contents

Before use

Warning.....	3
Safety precautions	5
Handling Compact discs.....	7

Buttons and Display

Basic operations.....	8
Tuner features.....	8
RBDS features.....	9
Disc control features.....	9
Other features.....	10
Remote.....	10

Basic operations

Stealth Retraction Mechanism.....	11
Switching Modes	12
Volume.....	12
Loudness	12
Attenuator.....	12
Attenuator Gain Selection.....	12
Menu System.....	13

Tuner features

Tuning.....	14
Station Preset Memory.....	14
Auto Memory Entry.....	14
Clean Reception System Circuit (CRSC).....	15
Switching Display for Tuner.....	15
Station Name Preset (SNPS).....	16
Direct Access Tuning.....	17
Station Name Preset Play (SNPP).....	17

RBDS features

RBDS (Radio Broadcast Data System).....	18
Alarm.....	18
Traffic Information Function.....	18
Program Type (PTY) Function.....	18
Radio Text.....	20
Radio Text Scroll.....	20

Disc control features

Playing CDs.....	21
Playing other Disc mode.....	21

Fast Forwarding and Reversing Disc Play.....	22
Track Search.....	22
Disc Search.....	22
Track / Disc Repeat.....	22
Track Scan.....	23
Disc Scan.....	23
Random Play.....	23
Magazine Random Play.....	23
Switching Display for Discs.....	24
Text Scroll.....	24
Presetting Disc Names.....	25
Direct Track Search.....	26
Direct Disc Search.....	26
Disc Name Preset Play (DNPP).....	26

Other features

Audio Control Setting.....	27
Table of Audio Control Setting.....	28
Balanced Output.....	28
Dimmer.....	29
Selectable Illumination.....	29
Touch Sensor Tone.....	29
Switching Clock Display.....	30
Switching Graphic Display.....	30
Adjusting Time.....	31
Security Code.....	32

Basic operations of remote.....

Installation

Accessories.....	35
Installation Procedure.....	35
Connecting Wires to Terminals.....	36
Installation (non-Japanese cars).....	37
Removing the Unit.....	38
Installation (Japanese-cars).....	39

Troubleshooting guide.....

Specifications.....

▲ Warning



Dear Customer:

Selecting fine audio equipment such as the unit you've just purchased is only the start of your musical enjoyment. Now it's time to consider how you can maximize the fun and excitement your equipment offers. This manufacturer and the Electronic Industries Association's Consumer Electronics Group want you to get the most out of your equipment by playing it at a safe level. One that lets the sound come through loud and clear without annoying blaring or distortion — and, most importantly, without affecting your sensitive hearing.

Sound can be deceiving. Over time your hearing "comfort level" adapts to higher volumes of sound. So what sounds "normal" can actually be loud and harmful to your hearing. Guard against this by setting your equipment at a safe level **BEFORE** your hearing adapts.

To establish a safe level:

- Start your volume control at a low setting.
- Slowly increase the sound until you can hear it comfortably and clearly, and without distortion.

Once you have established a comfortable sound level:

- Set the dial and leave it there.

Taking a minute to do this now will help to prevent hearing damage or loss in the future. After all, we want you listening for a lifetime.



We Want You Listening For A Lifetime

Used wisely, your new sound equipment will provide a lifetime of fun and enjoyment. Since hearing damage from loud noise is often undetectable until it is too late, this manufacturer and the Electronic Industries Association's Consumer Electronics Group recommend you avoid prolonged exposure to excessive noise. This list of sound levels is included for your protection.

Decible Level Example

30	Quiet library, soft whispers
40	Living room, refrigerator, bedroom away from traffic
50	Light traffic, normal conversation, quiet office
60	Air conditioner at 20 feet, sewing machine
70	Vacuum cleaner, hair dryer, noisy restaurant
80	Average city traffic, garbage disposals, alarm clock at two feet.

THE FOLLOWING NOISES CAN BE DANGEROUS UNDER CONSTANT EXPOSURE

90	Subway, motorcycle, truck traffic, lawn mower
100	Garbage truck, chain saw, pneumatic drill
120	Rock band concert in front of speakers, thunderclap
140	Gunshot blast, jet plane
180	Rocket launching pad

Information courtesy of the Deafness Research Foundation.



▲ Warning**▲ CAUTION**

Use of controls or adjustments or performance of procedures other than those specified herein may result in hazardous radiation exposure.

In compliance with Federal Regulations, following are reproductions of labels on, or inside the product relating to laser product safety.

KENWOOD CORPORATION
2967-3, ISHIKAWA-CHO,
HACHIOJI-SHI
TOKYO, JAPAN

KENWOOD CORP. CERTIFIES THIS EQUIPMENT
CONFORMS TO DHHS REGULATIONS N0.21 CFR
1040. 10, CHAPTER I, SUBCHAPTER J.

Location : Bottom Panel

FCC WARNING

This equipment may generate or use radio frequency energy. Changes or modifications to this equipment may cause harmful interference unless the modifications are expressly approved in the instruction manual. The user could lose the authority to operate this equipment if an unauthorized change or modification is made.

NOTE

This equipment has been tested and found to comply with the limits for a Class B digital device, pursuant to Part 15 of the FCC Rules. These limits are designed to provide reasonable protection against harmful interference in a residential installation. This equipment may cause harmful interference to radio communications, if it is not installed and used in accordance with the instructions. However, there is no guarantee that interference will not occur in a particular installation. If this equipment does cause harmful interference to radio or television reception, which can be determined by turning the equipment off and on, the user is encouraged to try to correct the interference by one or more of the following measures:

- Reorient or relocate the receiving antenna.
- Increase the separation between the equipment and receiver.
- Connect the equipment into an outlet on a circuit different from that to which the receiver is connected.
- Consult the dealer or an experienced radio/TV technician for help.

NOTE

This Class B digital apparatus meets all requirements of the Canadian interference-Causing Equipment Regulations.

Safety precautions

▲WARNING

To prevent injury or fire, take the following precautions:

- Insert the unit all the way in until it is fully locked in place. Otherwise it may fall out of place when jolted.
- When extending the ignition, battery, or ground wires, make sure to use automotive-grade wires or other wires with a 0.75mm² (AWG18) or more to prevent wire deterioration and damage to the wire coating.
- To prevent a short circuit, never put or leave any metallic objects (such as coins or metal tools) inside the unit.
- If the unit starts to emit smoke or strange smells, turn off the power immediately and consult your Kenwood dealer.
- Make sure not to get your fingers caught between the faceplate and the unit.
- Be careful not to drop the unit or subject it to strong shock.
The unit may break or crack because it contains glass parts.
- Do not touch the liquid crystal fluid if the LCD is damaged or broken due to shock. The liquid crystal fluid may be dangerous to your health or even fatal.
If the liquid crystal fluid from the LCD contacts your body or clothing, wash it off with soap immediately.

▲CAUTION

To prevent damage to the machine, take the following precautions:

- Make sure to ground the unit to a negative 12V DC power supply.
- Do not open the top or bottom covers of the unit.
- Do not install the unit in a spot exposed to direct sunlight or excessive heat or humidity. Also avoid places with too much dust or the possibility of water splashing.
- Do not subject the faceplate to excessive shock, as it is a piece of precision equipment.
- When replacing a fuse, only use a new one with the prescribed rating. Using a fuse with the wrong rating may cause your unit to malfunction.
- To prevent a short circuit when replacing a fuse, first disconnect the wiring harness.
- Do not place any object between the faceplate and the unit.
- Do not use your own screws. Use only the screws provided. If you use the wrong screws, you could damage the unit.

IMPORTANT INFORMATION

You cannot connect the unit directly to the following CD automatic changers. If you want to use older changers with the unit, follow the directions below according to the type of changer you own:

• KDC-C200 / KDC-C300 / KDC-C400

Use the extension cable and the control box attached to the CD changer, and the optional CA-DS100 converter cord.

• KDC-C301 / KDC-C600 / KDC-C800 / KDC-C601 / KDC-C401

Use the extension cable attached to the CD changer, and the optional CA-DS100 converter cord.

• KDC-C100 / KDC-C302 / C205 / C705 / non-Kenwood CD changers

Cannot be used with this model.

▲CAUTION

You can damage both your unit and the CD changer if you connect them incorrectly.

Safety precautions

NOTE

- If you experience problems during installation, consult your Kenwood dealer.
- If the unit fails to operate properly, press the RESET button. When the faceplate is not visible, press "the touch-sensitive spot" at the rear of the faceplate (as illustrated on p.11) to make the faceplate control appear. The unit returns to factory settings when the RESET button is pressed. If the unit still fails to operate properly after the RESET button has been pressed, contact your local KENWOOD dealer for assistance.
- Press the reset button if the disc auto changer is first controlled and operates incorrectly. The original operating condition will return.

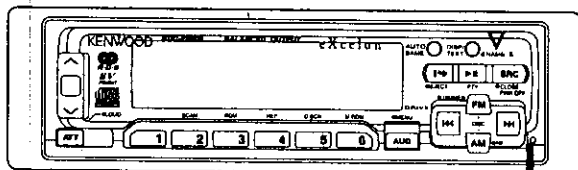

Reset button

- We recommend the use of the Security Code function (see p.32) to prevent theft.

Cleaning the Unit

If the front panel gets dirty, turn off the power and wipe the panel with a dry silicon cloth or soft cloth.

CAUTION

Do not wipe the panel with a hard cloth or a cloth dampened by volatile solvents such as paint thinner and alcohol. They can scratch the surface of the panel and/or cause the indicator letters to peel off.

Cleaning the CD Slot

As dust tends to accumulate in the CD slot, clean it every once in a while. Your CDs can get scratched if you put them in a dusty CD slot.

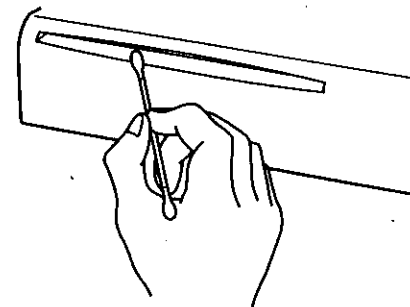

Lens Fogging

Right after you turn on the car heater in cold weather, dew or condensation may form on the lens in the CD player of the unit. Called lens fogging, CDs may be impossible to play. In such a situation, remove the disc and wait for the condensation to evaporate. If the unit still does not operate normally after a while, consult your Kenwood dealer.

Handling Compact discs

Playing a CD that is dirty, scratched or warped can cause the sound to skip and the unit to operate incorrectly, resulting in worsened sound quality. Take the following precautions to prevent your CDs from getting scratched or damaged.

Handling CDs

- Do not touch the recorded side of the CD (the side opposite the label) when holding it.

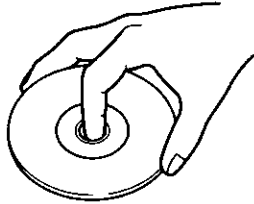

- Do not stick tape on either side of the CD.

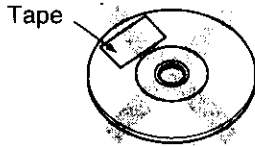

Storing CDs

- Do not store CDs in areas exposed to direct sunlight (such as a car seat or the dashboard) or other hot places.
- Remove CDs from the unit when not listening to them for a while, and put them back in their cases. Do not pile up CDs that are removed from their cases or prop them against something.

Cleaning CDs

If a CD has gotten dirty, wipe it off gently using a commercially available cleaning cloth or a soft cotton cloth, starting from the center of the disc and moving outward. Do not clean CDs with conventional record cleaners, anti-static formulas, or chemicals such as paint thinner or benzene.

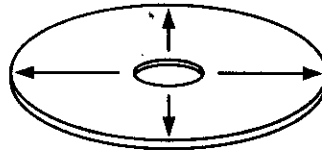

Checking New CDs for Burrs

When playing a new CD for the first time, check that there are not any burrs stuck to the perimeter of the disc or in the central hole. CDs with burrs stuck on them may not load properly or may skip while playing. Remove burrs using a ballpoint pen or a similar utensil.

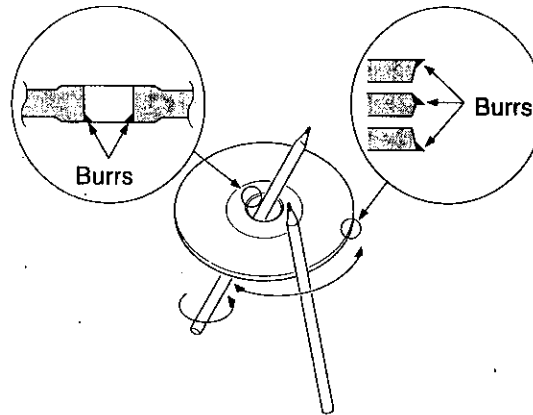

Do Not Load CD Accessories

Do not use commercially available CD accessories that can be loaded into the CD slot, such as stabilizers, protective sheets, or CD cleaning discs, since they can cause the unit to malfunction.

Removing the CD

Only remove the CD from the machine in a horizontal direction, holding it flat. You may damage the surface of the CD if you try pulling it down as it ejects.

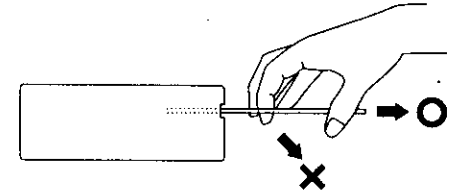

CAUTION

Do Not Load 3-in. CDs in the CD slot

If you try to load a 3 in. CD with its adapter into the unit, the adapter might separate from the CD and damage the unit.

Do Not Use Special Shape CDs

- Be sure to use round shape CDs only for this unit and do not use any special shape CDs. Use of special shape CDs may cause the unit to malfunction.

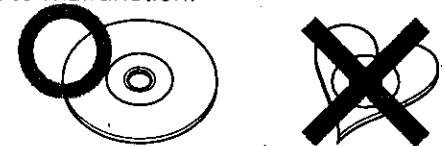

- Be sure to use CDs with disc mark  only for this unit.

Buttons and Display

Basic operations

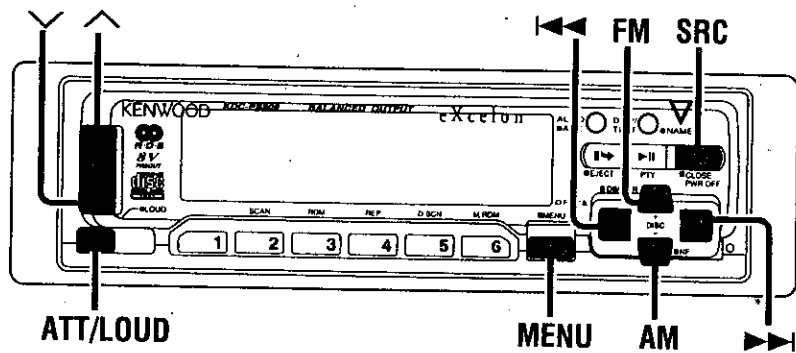

Tuner features

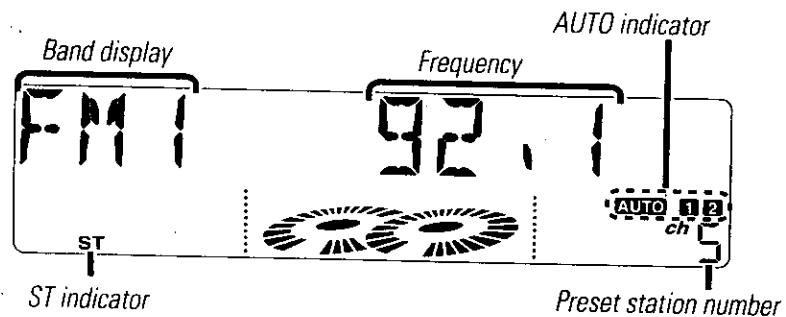
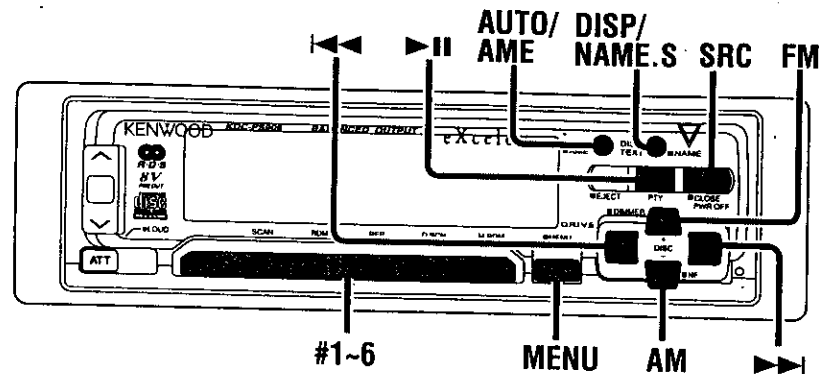

RBDS features

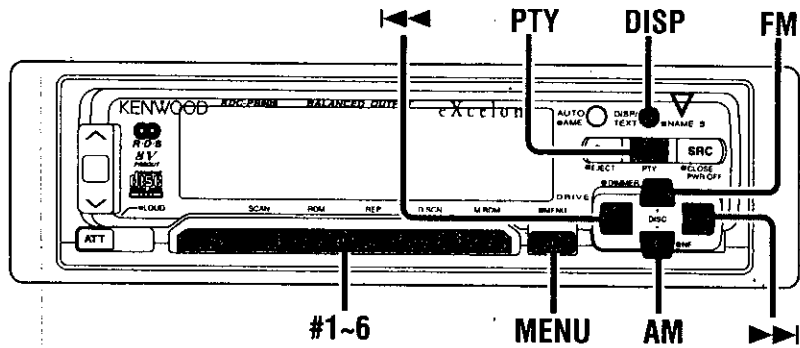

Disc control features

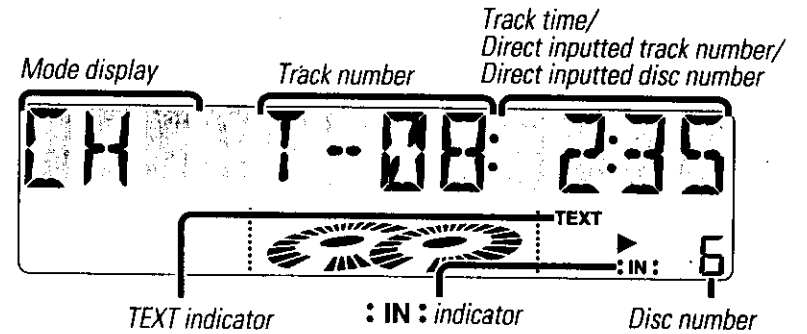
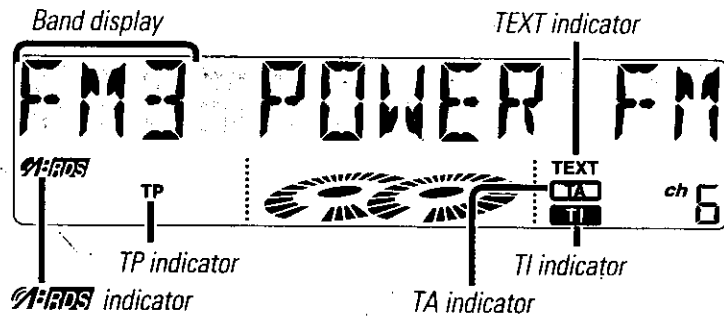
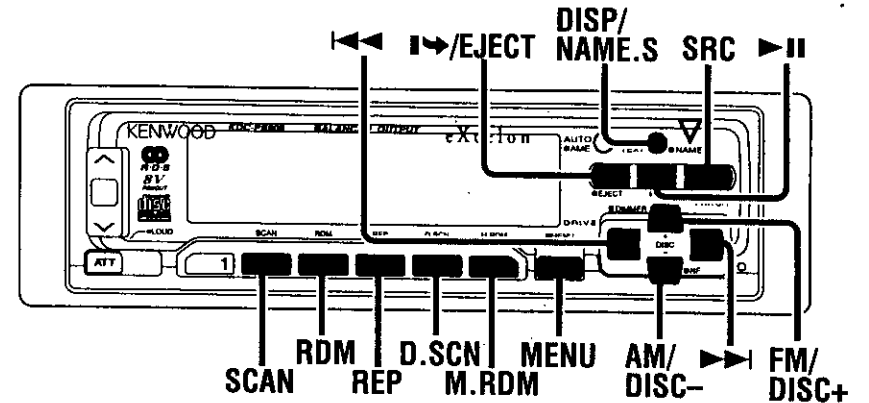

Buttons and Display

Other features

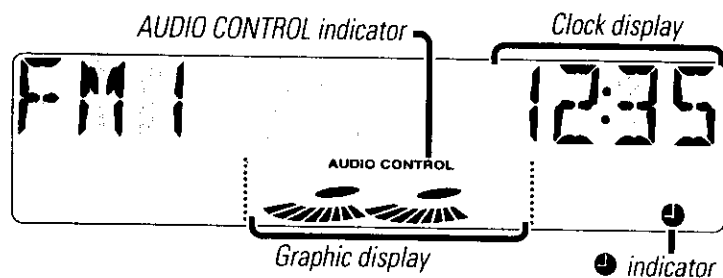
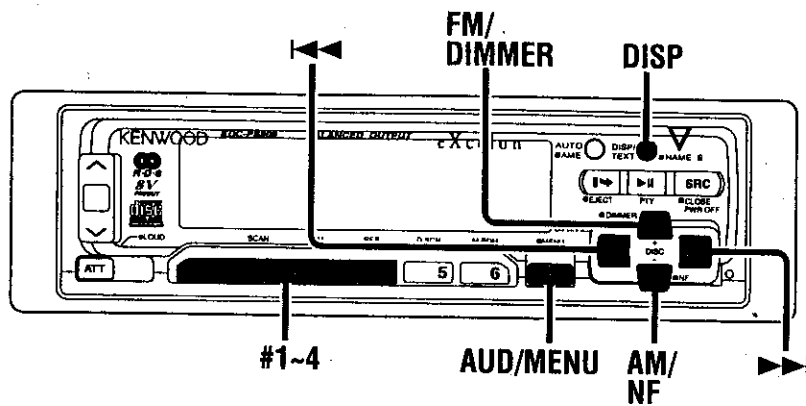

Remote

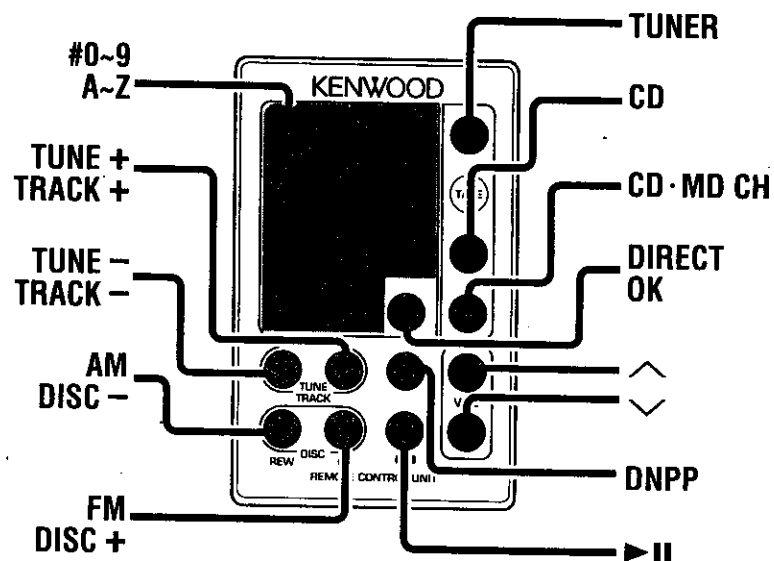

Stealth Retraction Mechanism

You can help prevent theft of the unit by reversing the faceplate so that the control panel cannot be seen, hiding the unit, and shutting off the audio.

Power ON/OFF:

When you turn your vehicle's ignition on, the unit's power will also turn on, with the faceplate reversing to show the control panel.

When you turn your vehicle's ignition off, the faceplate will reverse to hide the control panel, and the unit's power will turn off.

NOTE

- When the moving faceplate is hit by an object, it will stop and return to its original state. Remove the object and repeat the action.
- The status of the Security Code Function (P.32) is displayed whenever the power is switched on.
"CODE ON" (Security Code has been registered)
"CODE OFF" (Security Code has not been registered)

CAUTION Using the Unit in Vehicles with Covered Consoles

- Make sure the console is uncovered while the faceplate is reversed.
- Do not exert any excess force on the movable parts of the unit, including the faceplate, as it can cause failure in the unit's mechanism.

Hiding the unit with the ignition turned on (forced closing):

Keep pressing the SRC button for at least one second.

The faceplate will reverse, hiding the unit. The unit will turn off.

NOTE

- When the closing faceplate is hit by an object, the unit will turn off without the faceplate closing all the way. Remove the object and press the SRC button to turn the unit back on, then turn it off again to have it close properly.
- While the control panel is moving, pressing the buttons will not have any effect. Do not try to press the buttons on the control panel as the faceplate is moving, as excessive force may damage the unit.

- During the forced closing of the unit (i.e., having the unit left closed while ignition is turned on), the faceplate will not open no matter how often the ignition is turned on or off, unless "the touch-sensitive spot" at the rear of the faceplate is pressed in order to open it. You can prevent tampering of the unit when letting someone else drive your car by keeping it closed this way.

To cancel the stealth retraction mechanism's forced closing of unit and open control panel:

Press "the touch-sensitive spot" at the rear of the faceplate. (as illustrated)

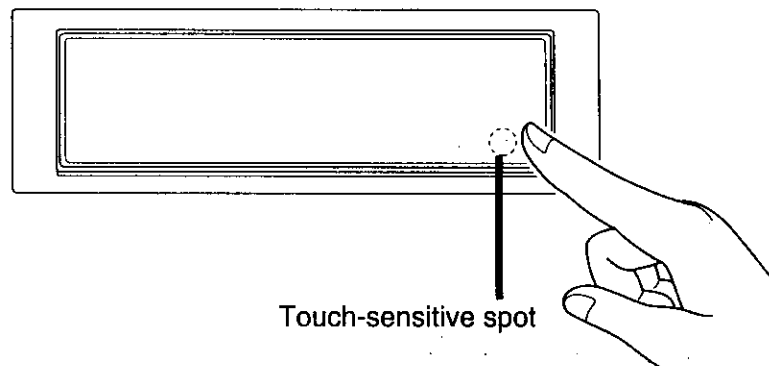

NOTE Touch-sensitive spot

The invisible switch is hiding behind the touch-sensitive spot. Press the hollow spot (invisible switch) to open.

Basic operations (See page 8)

Switching Modes

Switching Modes:

Each time you press the SRC (source) button, the mode switches as follows:

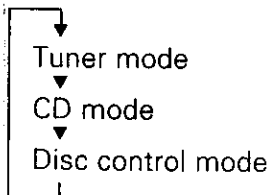

NOTE

- The mode switches to the next mode from any mode which cannot be used.
- The disc control mode will differ depending on the unit that is connected.

Volume

Increasing Volume:

Press the \wedge button to turn up the volume.

Decreasing Volume:

Press the \vee button to turn down the volume.

Loudness

This function amplifies low and high tones when the volume is turned down.

The LOUD indicator lights up when the loudness function is on.

Turning Loudness On/Off:

Press the LOUD button for at least one second to switch the loudness on and off.

Attenuator

This function allows you to turn down the volume quickly.

Turning Attenuator On/Off:

Press the ATT button to switch the attenuator on and off. When the attenuator is on, the ATT indicator blinks. When the attenuator is off, the volume returns to the original level.

NOTE

Turning the volume all the way down deactivates the attenuator function.

Attenuator Gain Selection

The attenuator gain can be switched to either -20 dB or -60 dB. Choose the -60dB setting when using a high-output amplifier. The factory default is -20dB.

- 1 Press the MENU button for at least one second. "MENU" is displayed and the menu mode is turned on.
- 2 Keep pressing the $\blacktriangleright\blacktriangleright$ button until the Attenuator Gain Selection function appears in the display. Press the $\blacktriangleleft\blacktriangleleft$ button to search in the other direction. The function setting is indicated by "ATT LOW" or "ATT HIGH" in the display, indicating that the current setting is low or high, respectively. When "ATT LOW" is displayed, the attenuator gain is set at -20dB. When "ATT HIGH" is displayed, it is set at -60dB.
- 3 **Switching settings**
Press either the AM or FM button. The display and setting will change.
- 4 Press the MENU button to end the menu mode.

Menu System

To accommodate a greater number of functions, a menu system has been employed for making settings. Press the **MENU** button to enter the menu mode and then display the function to make the setting. Details on each setting are explained separately in the corresponding function page.

- 1 Press the MENU button for at least one second.
"MENU" is displayed when the menu mode is entered.
The function that you can adjust is indicated with the current settings displayed.
- 2 **Selecting function to set**
Press the ►► button to search through the functions until you see the one you want to adjust in the display.
Press the ◄◄ button to search through the functions backward.
Example: If you want to switch the clock display function from on to off, first search through the functions until you see "CLOCK ON" in the display.

CLOCK ON

3 Changing setting for currently displayed function

Press either the AM or FM button.
The setting will change for each function.
Example: The clock display function will switch from on to off, and "CLOCK OFF" is displayed.

CLOCK ON → CLOCK OFF

4 Ending the menu mode

Press the MENU button.

NOTE

Make sure to end the menu mode when finished.
If you fail to end the menu mode, several functions may not operate properly, including the Traffic Information function and the Alarm function.

Function	Varieties of settings for each function (display)
Switching Clock Display	CLOCK ON ↔ CLOCK OFF ↑↓
Time Adjustment (Manual) <When Automatic Time Adjustment is off>	CLOCK ADJUST (Time Adjustment mode entered) ↑↓
Automatic Time Adjustment	SYNC OFF ↔ SYNC ON ↑↓
Security mode	SECURITY ↑↓
Selectable Illumination	COLOR GREEN → COLOR AMBER → ILLUMI OFF ↑↓
Attenuator Gain Selection	ATT LOW ↔ ATT HIGH ↑↓
Switching Graphic Display	GRAPHIC ON ↔ GRAPHIC OFF ↑↓
Touch Sensor Tone	BEEP ON ↔ BEEP OFF ↑↓
Balanced output	UNBALANCED ↔ BALANCED ↑↓
Traffic Information Function	T.I OFF ↔ T.I ON ↑↓
Clean Reception System Circuit <In FM reception of Tuner mode>	CRSC ON ↔ CRSC OFF ↑↓
Text Scroll <In FM, CD mode>	SCROLL AUTO ↔ SCROLL MANU ↑

Tuner features (See page 8)

Tuning

You can choose from three tuning modes: auto seek, preset station seek, and manual. The "AUTO1" indicator lights up when auto seek tuning is selected, and the "AUTO2" indicator lights when preset station seek tuning is selected.

Selecting Tuning Mode:

Press the AUTO button.

Each time you press the AUTO button, the mode switches as follows.

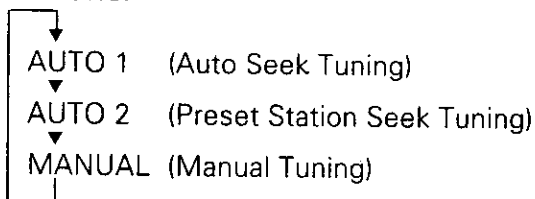

Tuning:

- 1 Press the SRC (source) button repeatedly to select the tuner mode. "TUNER" is displayed when the tuner mode has been selected.
- 2 Press either the FM or AM button to select the band. Each time you press the FM button, the band switches between the FM1, FM2 and FM3 (which are used for groups of preset stations). Press the AM button to select the AM band.
- 3
 - Auto Seek Tuning
 - Press the ►► button to seek higher frequencies.
 - Press the ◄◄ button to seek lower frequencies.
 - Preset station seek tuning
 - Press the ►► button to move to the next preset station (i.e., the one with the next highest number), and the ◄◄ button to move to the last preset station (i.e., the one with the next lowest number).
 - Manual Tuning
 - Press the ►► button to increase the frequency by one step.
 - Press the ◄◄ button to decrease the frequency by one step.

NOTE

The ST indicator lights up when stereo broadcasts are being received.

Station Preset Memory

Store the frequency of a station. You can then recall that station with a single touch of a button.

- 1 Select the band/station that you want to have stored.
- 2 Press the button (#1-6) that you want to use for the station, for at least two seconds. The button number blinks once in the display to indicate that the data has been stored.

Recalling a Preset Station:

Press the preset station button (#1-6) for the desired station. The number of the recalled station is displayed.

NOTE

You can store six stations in each of the FM1, FM2, FM3, and AM bands.

Auto Memory Entry

You can automatically store all the receivable frequencies in the band currently being listened to, and then recall them with the touch of a button later. This function is especially useful when you are travelling and do not know what stations are available. Up to six frequencies can be stored this way.

- 1 Select the band for which you want to store stations.
- 2 Press the AME button for at least two seconds to start auto memory entry. The numbers of the preset station buttons are shown in order. When all the stations in a certain band are stored in the preset memory, the auto memory entry stops. The tuner then plays the last station received.

Recalling a Preset Station:

Press the preset station button (#1-6) for the desired station. The number of the recalled station is displayed.

Clean Reception System Circuit (CRSC)

Temporarily have reception switched from stereo to mono to reduce multi-path noise when listening to the FM station. The factory default for this function is ON.

Turning CRSC On/Off:

- 1 Press the MENU button for at least one second. "MENU" is displayed and the menu mode is turned on.
- 2 Keep pressing the ►► button until the Clean Reception System Circuit function appears in the display. Press the ◀◀ button to search in the other direction. The function setting is indicated by "CRSC ON" or "CRSC OFF" in the display, indicating that the CRSC is on or off, respectively.
- 3 **Switching settings**
Press either the AM or FM button. The display and setting will change.
- 4 Press the MENU button to end the menu mode.

NOTE

Strong electrical fields (such as from power lines) may cause unstable sound quality when CRSC is turned on. In such a situation, turn it off.

Switching Display for Tuner

You can change the display used when listening to the radio.

Changing the Display:

Each time you press the DISP button, the display changes as follows:

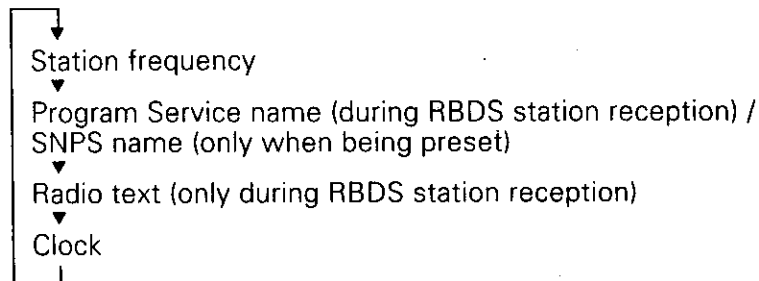

NOTE

- When receiving an RBDS station to which a name has been preset with Station Name Preset, switching to the program service name/SNPS name display will result in the program service name being displayed with priority.
- Only when the Switching Clock display function (P.30) is on, the clock is displayed.
- The ● indicator lights while the clock is displayed.

Tuner features (See page 8)

Station Name Preset (SNPS)

You can assign names to radio stations with the Station Preset Memory. Up to 32 FM stations and 16 AM stations can be assigned names.

- Adjust the frequency to the station whose name you want to enter.
- Press the NAME.S button for at least two seconds. "NAME SET" is displayed once the station name preset mode is entered. The cursor will blink in the position where letters are entered.
- Press either the ◀◀ or ▶▶ button to move the cursor to the desired position. The ◀◀ button moves the cursor to the left, and the ▶▶ button to the right. You can also move the cursor left or right by pressing the TUNE- or TUNE+ buttons, respectively, on the remote.
- Press the FM or AM button to display the desired character. Besides the alphabet (capital letters only) and numerals, you can choose the following characters: /, +, -, *, =, <, >, [and].

NOTE Direct Alphabet Input

Direct input can be made of letters (alphabetical) with the letter entry buttons on the remote.

Example: Use the following table to enter the name "DANCE".

Character	Button to press	# Times pressed
"D"	#3	1
"A"	#2	1
"N"	#6	2
"C"	#2	3
"E"	#3	2

- Continue steps 3 and 4 until all the characters are chosen for the name.

NOTE

You can enter up to 8 characters for each name.

- Assigning Names
Press the NAME.S button on the unit or the OK button on the remote. The name of the station is stored in memory, and the Station Name Preset mode ends.
 - Assigning Name and Storing Frequency with Station Preset Memory
Hold down the desired preset button for at least two seconds. The name of the station is stored and the frequency for the current station is stored in the selected preset button. The Station Name Preset mode ends. Also, if you make no input for 10 seconds, the name will be stored up to the point that you have entered, and the mode ends.

NOTE

- You can assign names to up to 32 FM stations and 16 AM stations.
- All the station names will be erased if you press the RESET button.
- If you want to change the name of a station, first display the name of the station (following steps 1 and 2 above), then change the letter(s) that you want by following steps 3 and 4.

Direct Access Tuning

When you know the frequency of the station that you want to listen to, you can input it directly for quick access.

- 1 Select the band by pressing the FM or AM button.
- 2 Press the DIRECT button.
The frequency part of the display blinks for 10 seconds.
If you make no input in the 10-second period, direct access tuning is automatically canceled.
- 3 Enter the frequency of the desired station while the display is blinking.
If you want to listen to an FM station at 92.1 MHz, for example, press 0, 9, 2, and 1.
If you want to listen to an AM station at 810 kHz, for example, press 0, 8, 1, and 0.

NOTE

When a frequency which cannot be received is input, this frequency is not verified and operation returns to the original frequency input mode.

Canceling Direct Access Tuning:

Press the DIRECT button again.

Station Name Preset Play (SNPP)

You can search for the station for any station if its name has been preset using Station Name Preset.

- 1 Press the DNPP button on the remote.
"SNP PLAY" will be displayed once the station name preset play mode is entered.
The names of the stations stored in the band currently listened to are displayed in the following order for five seconds each:
FM1, FM2, FM3, and AM.
Each time you press the TUNE+ button, the station display switches in the forward direction.
Each time you press the TUNE- button, the station display switches in the reverse direction.
Stations whose names have not been stored will be displayed as frequencies.
The program service name will appear for RBDS stations.

NOTE Changing the Displayed Band

Pressing the FM button switches between the FM1, FM2, FM3 and AM displays, in that order.
Pressing the AM button switches between the displays in the reverse direction.

- 2 **Once the name is displayed for the station you want to listen to**

Press the OK button.

Reception starts of the displayed station, and the station name preset play mode ends..

Canceling mode during input:

Press the DNPP button.

The station name preset play mode is canceled.

RBDS features (See page 9)**RBDS (Radio Broadcast Data System)**

RBDS is a service used by radio stations to transmit data outside normal radio broadcast signals.

When an RBDS station is received, you can immediately find out what kind of data is being transmitted by looking at the program service name, which appears in the display after the frequency.

The **RBDS** indicator turns on when an RBDS station is being received.

Alarm

When an emergency transmission (announcing disasters, etc.) is made, the current function will be interrupted to allow the warning to be received under the following conditions: during tuner reception, or when the Traffic Information function is turned on.

Traffic Information Function

You can listen to traffic information. If you are listening to tapes or discs, they will continue playing until a traffic bulletin is broadcast.

Turning TI function On/Off:

- 1 Press the MENU button for at least one second. "MENU" is displayed and the menu mode is turned on.
- 2 Keep pressing the **▶▶** button until the Traffic Information function appears in the display. Press the **◀◀** button to search in the other direction. The function setting is indicated by "T.I ON" or "T.I OFF" in the display, indicating that the TI function is on or off, respectively.

3 Switching settings

Press either the AM or FM button.

The display and setting will change.

When the function is on, the TI indicator is turned on.

When a traffic information station is being received, the TI indicator will turn on. When none is being received, the TI indicator will blink on and off.

When a traffic bulletin begins to be broadcast, the TA indicator will turn on.

If you are listening to a tape or disc when a traffic bulletin begins, they will automatically be turned off. When the bulletin ends or poor reception is experienced, the tape or disc will begin playing again.

- 4 Press the MENU button to end the menu mode.

NOTE**Switching to a Different Traffic Information Station:**

Use the **◀◀** / **▶▶** buttons to make an auto seek of the TI stations in a certain band.

NOTE

- When you are listening to a tape or disc, you cannot change to another TI station.
- When you turn on the TI function, the motorized antenna will extend automatically.

Program Type (PTY) Function

Conduct auto seek tuning only on those stations with selected kinds of programs.

To enter the program type selection mode:

- 1 Press the PTY button. "PTY" is displayed once the program type selection mode is entered.

NOTE

You cannot use this function while the traffic information function is turned on.

2 Select the type of program to be received

- Press either the FM or AM buttons repeatedly to select the type of program you want to listen to.

The selection includes:

Speech ↔ 1. News(NEWS) ↔ 2. Information(INFORM) ↔
3. Sports(SPORTS) ↔ 4. Talk(TALK) ↔ 5. Rock(ROCK) ↔
6. Classic Rock(CLS ROCK) ↔ 7. Adult Hits(ADLT HIT) ↔
8. Soft Rock(SOFT RCK) ↔ 9. Top 40(TOP 40) ↔
10. Country(COUNTRY) ↔ 11. Oldies(OLDIES) ↔
12. Soft(SOFT) ↔ 13. Nostalgia(NOSTALGA) ↔ 14.
Jazz(JAZZ) ↔ 15. Classical(CLASSICL) ↔ 16. R&B(R & B) ↔
17. Soft R&B(SOFT R&B) ↔ 18. Language(LANGUAGE) ↔
19. Religious Music(REL MUSC) ↔ 20. Religious Talk(REL
TALK) ↔ 21. Personality(PERSNLTY) ↔ 22. Public(PUBLIC)
↔ Music ↔ Speech ↔
(Speech.....1~4, 18, 20~22, Music.....5~17, 19)

- You can select the type of program directly by pressing a preset button. The buttons are factory-set to the following type of programs:

1. Music	2. Speech	3. News
4. Sports	5. Classical	6. Jazz

NOTE Changing the Preset Button Settings for Program Type
After selecting the type of program to be stored in a certain preset button, hold down that button for at least two seconds. The previously stored data for that button are erased and the new program type is stored.

3 Seeking the Selected Program Type

Press the ◀◀ or ▶▶ button to make a seek of frequencies with your selected type of program.
The display blinks and the seek starts.

If your selected type of program is found, the name or the frequency of the station is displayed and the station is tuned into.

"PTY" blinks in the display for about 30 seconds.

If you make no key input in 30 seconds, the PTY selection mode will turn off automatically.

NOTE

If no program can be found, "NO PTY" is displayed.
If you want to select another type of program, repeat steps 2 and 3 above.

Switching to Other Stations with the Same Type of Program:

When "PTY" is blinking in the display, perform auto seek

tuning.

The tuner scans for another station with the same type of program.

Canceling Program Type Function During Its Operation:

Press the PTY button.

Confirming Program Type:

Press the DISP button.

The program type of the station currently tuned to will be displayed for five seconds. During that time, "E" will blink in the display.

NOTE

If you tune to frequencies for which no program type has been stored, "NO ENTRY" will be displayed.

To register a station as a program type:

- 1 Tune your radio to the station that you want to register as the program type.
- 2 Press the PTY button to enter the program type selection mode.
- 3 Press the FM/AM button to select the program type you want to register. Follow the instructions in 2 to enter the program type selection mode.
- 4 Press the DISP button for at least two seconds.
The station will be registered as a program type, allowing it to be the target of frequency seeks just as RBDS stations are.

NOTE

- You cannot register the station as the program types that are "MUSIC" and "SPEECH".
 - You can store up to 64 stations.
If you try to store a 65th station, the frequency and program type will appear alternately in the display.
In that case, press the FM/AM button to change the display to a station that you want to erase, and then press the DISP button again for at least two seconds. The newly entered station will thus be stored.
- 5 Press the PTY button to end the program type selection mode.

RBDS features (See page 9)**Radio Text**

You can display textual information being transmitted by RBDS stations.

Turning on Radio Text Display Mode:

Pressing the DISP button switches the display as follows. Select the Radio Text Display mode.

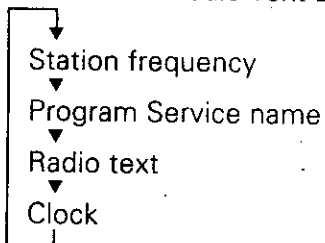
**NOTE**

- If the RBDS station currently tuned to is transmitting no text while the Radio Text Display mode is turned on, "NO TEXT" will appear in the display. While awaiting reception, "WAITING" will scroll across the display.
- Only when the Switching Clock display function (P.30) is on, the clock is displayed.
- The ● indicator lights while the clock is displayed.

▲WARNING

To prevent accidents, drivers should not look at the display while on the road.

Radio Text Scroll

This function permits the text to be scrolled and the entire text to be displayed. Switching between manual scrolling and automatic scrolling is permitted. The factory default is automatic scrolling.

To scroll automatically:

Press the DISP button to display the Radio Text. The display of the text will be scrolled repeatedly.

Manual/Automatic scroll switching:

- 1 Press the MENU button for at least one second. "MENU" is displayed and the menu mode is turned on.
- 2 Keep pressing the ►► button until the Text scroll function appears in the display. Pressing the ◀◀ button results in the functions being switched in the reverse order. The text scroll function is displayed with "SCROLL MANU" or "SCROLL AUTO".
"SCROLL MANU" (Manual scrolling)
"SCROLL AUTO" (Automatic scrolling)
- 3 **Switching settings**
Press either the AM or FM button. The display and setting will change.

- 4 Press the MENU button to end the menu mode.

To scroll manually:

- 1 Press the DISP button to display the Radio Text.
- 2 Pressing the DISP button for at least one second results in one scrolling display of the text.

NOTE

The setting of the text scroll function is in common with Text Scroll of the disc control mode.

Playing CDs

Play:

Press the **EJECT** button to slide open the faceplate, showing the CD (insertion) slot. Holding the CD with the labeled side facing up, insert it in the slot. The faceplate will show the control panel, and the CD will start playing. The **IN** indicator will light when a CD has been inserted.

Playing CDs Already Inserted:

Press the SRC button repeatedly to select the CD mode. "CD" is displayed when the CD mode has been selected. The CD will start playing.

Pausing and Restarting CD Play:

Press the **PAUSE** button to make the disc pause. Press the same button again to start play again.

Eject:

Press the **EJECT** button for at least one second to stop CD play. The faceplate will slide to eject the CD. Press the **EJECT** button to show the control panel.

CAUTION

- Do not attempt to insert a CD into the slot if another one is already there.
- The unit can only play 5 in. CDs. If you insert a 3 in. CD, it will get stuck inside and can cause the unit to malfunction.

NOTE

- The sound will be temporarily muted while the faceplate is moving.
- The only buttons that will work during the eject state are the **EJECT**, SRC and ATT buttons, as well as the volume control button.
- When you load a CD and eject it right away, the next time you try to insert the CD may not load. In such a situation, take the CD out for a moment and then reinsert it.

When the disc changer with the O-N selection switch is connected, set the switch to "O" position to operate the disc changer mode.

Playing other Disc mode

This function permits the connection of optional players and the playing of discs other than the loaded CD (in the current unit).

Playing Discs:

Press the SRC button repeatedly to select the disc control mode. The disc will start playing.

NOTE

The disc control mode will differ, depending on the unit that is connected.

Mode Display Examples

- "DISC"...when a disc changer is connected
- "DISC-1", "DISC-2"...when two disc changers are connected

Pausing and Restarting Disc Play:

Press the **PAUSE** button to make the disc pause. Press the same button again to start play again.

NOTE

- When one disc has finished playing its last track, the next disc in the changer will start playing. When the last disc in the changer has finished, the player will return to the first disc and start playing it.
- Disc #10 is displayed as "0".

Disc control features (See page 9)

Fast Forwarding and Reversing Disc Play

Fast Forwarding Disc Play:

Hold down on the ►► button.
Release your finger to play the disc at that point.

Reversing Disc Play:

Hold down on the ◀◀ button.
Release your finger to play the disc at the point.

NOTE

You cannot use reverse play between tracks depending on the model being connected. Instead, the reverse play function is canceled when it reaches the beginning of a track, at which point normal play will automatically resume.

Track Search

Search forward or backward through the tracks on the disc until you reach the one that you want to listen to.

Making a Reverse Track Search:

Press the ◀◀ button to display the desired track number.
Press once to search back to the beginning of the current track, twice to search back to the beginning of the previous track, and so forth.
Play starts at the beginning of the displayed track number.

NOTE (for disc changers)

Pressing the ◀◀ button while listening to track 1 will only search back to the beginning of that track. The reverse search is not "recycled" to the last track on the disc.

Making a Forward Track Search:

Press the ►► button to display the desired track number.
Press once to fast forward to the next track, twice to fast forward to the track after that, and so forth.
Play starts at the beginning of the displayed track number.

NOTE (for disc changers)

You cannot make a forward track search when listening to the last track on a disc.

Function of disc changers

Disc Search

Search forward or backward through the discs in a disc changer.

Making a Reverse Disc Search:

Press the DISC- button to display the desired disc number.
Each time the button is pressed, the displayed disc number decreases by one.
Play starts at the beginning of the displayed disc.

Making a Forward Disc Search:

Press the DISC+ button to display the desired disc number.
Each time the button is pressed, the displayed disc number increases by one.
Play starts at the beginning of the displayed disc.

NOTE

"LOAD" is displayed when discs are being exchanged on the disc changer.

Track / Disc Repeat

Repeat playing the track or the disc currently being listened to.

Turning Repeat Play On/Off:

Press the REP button to switch repeat track/disc play on and off as follows:

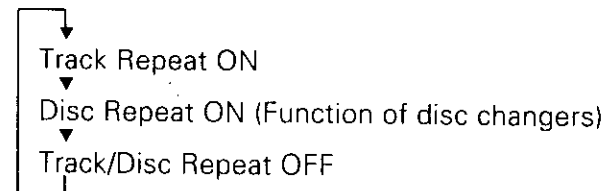

The track number blinks in the display when track repeat is on.
The disc number blinks in the display when disc repeat is on.

NOTE

Repeat play is canceled when you stop playing the disc.

Track Scan

Successively play the beginning of each track on a disc until you find the track that you want to listen to.

Turning Track Scan On/Off:

Press the SCAN button to switch track scan on and off.
The first 10 seconds of each track will be played, in order.
The track number currently being heard blinks in the display.

Stopping to Listen to the Track Being Scanned:

Press the ►|| or SCAN button again to stop the scan and keep on listening to a track normally.

NOTE

- Track scan is canceled when you stop playing a disc.
- Track scan only scans each track on a disc once.

Function of disc changers

Disc Scan

Successively play the beginning of each disc on a changer until you find the one that you want to listen to.

Turning Disc Scan On/Off:

Press the D.SCN button to switch disc scan on and off.
The first 10 seconds of each disc will be played, in the order they are loaded on the changer.
The disc number currently being heard blinks in the display.

Stopping to Listen to the Disc Being Scanned:

Press the ►|| or D.SCN button again to stop the scan and keep on listening to the disc normally.

NOTE

- Disc scan is canceled when you stop playing a disc.
- Disc scan only scans each disc on the changer once.
- "LOAD" is displayed when discs are being exchanged on the disc changer.

Random Play

Play all the tracks on the current disc in random order.

- 1 Press the RDM button to switch random play on and off.

The track number will change over and over in the display as the next track is being selected.

When the track has been selected, play will begin.

The selected track number blinks in the display as it is being played.

NOTE

When all the tracks on a certain disc have been played using random play, the next disc on the changer will start playing using the same function.

- 2 To change the track being heard, press the ►►| button. Another track will be selected and played.

NOTE

Random play is canceled when you stop playing a disc.

Function of disc changers

Magazine Random Play

Play the tracks on all the discs in the disc changer in random order.

- 1 Press the M.RDM button to switch magazine random play on and off.
The disc and track numbers will change over and over in the display as the next track is being selected.
When the disc/track has been selected, play will begin.
The selected disc/ track number blinks in the display as it is being played.

NOTE

This function is not available with the following models:
KDC-C200/C300/C400/C301/C401

- 2 To change the track being heard, press the ►►| button. Another disc/track will be selected and played.

NOTE

- Magazine random play is canceled when you stop playing a disc.
- The time needed for random selection depends on the number of discs loaded in the disc magazine.

Disc control features (See page 9)

Switching Display for Discs

Switch the display that appears while discs are playing.

Switching Display for Discs:

Each time you press the DISP button, the display during disc play switches as follows:

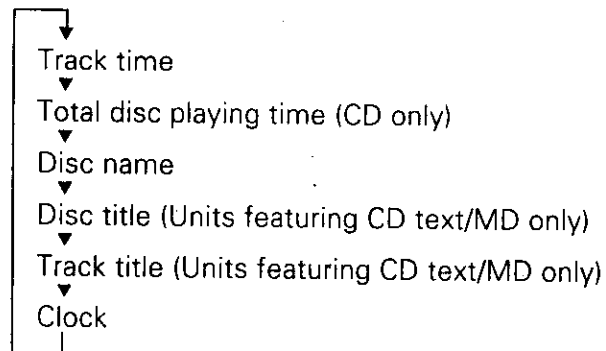

NOTE

- Disc title/ track title of the CD text cannot be displayed with the disc changers.
- You can give names to discs through the presetting disc name function (see p.25).
Note that depending on the unit, display may not be possible.
- If you try to display the name of a disc that doesn't have one, "NO NAME" is displayed instead.
- Only when the Switching Clock display function (P.30) is on, the clock is displayed.
- When there is an attempt to display the title of a disc for which the disc title/track title has not been recorded, "NO TEXT" is displayed for CD and "NO NAME" is displayed for MD.
- Depending on the type of characters of the CD Text, some characters may not be displayable.

Function of the CD mode with this unit

Text Scroll

This function permits the text to be scrolled and the entire text to be displayed. Switching between manual scrolling and automatic scrolling is permitted. The factory default is automatic scrolling.

To scroll automatically:

Press the DISP button to display the disc title or the track title. The display of the text will be scrolled repeatedly.

Manual/Automatic scroll switching:

- 1 Press the MENU button for at least one second. "MENU" is displayed and the menu mode is turned on.
- 2 Keep pressing the ►► button until the Text scroll function appears in the display. Pressing the ◄◄ button results in the functions being switched in the reverse order. The text scroll function is displayed with "SCROLL MANU" or "SCROLL AUTO".
"SCROLL MANU" (Manual scrolling)
"SCROLL AUTO" (Automatic scrolling)
- 3 **Switching settings**
Press either the AM or FM button. The display and setting will change.
- 4 Press the MENU button to end the menu mode.

To scroll manually:

- 1 Press the DISP button to display the disc title or the track title.
- 2 Pressing the DISP button for at least one second results in one scrolling display of the titles.

NOTE

The setting of the text scroll function is in common with Radio Text Scroll of the RBDS mode.

Presetting Disc Names

Store the names of discs to be displayed when played.

- 1 Play the disc whose name you want to preset.

NOTE

- This function is not available for disc changers that do not feature the Disc Name Preset function.
- This procedure is not to be used to store the disc and track titles for MDs that you record.

- 2 Press the NAME.S button for at least two seconds. "NAME SET" is displayed and the disc name preset mode is entered.
The cursor blinks in the position where character input can be made.

- 3 Press either the ◀◀ or ▶▶ button to move the cursor to the desired position.
The ◀◀ button moves the cursor to the left, and the ▶▶ button to the right.
You can also move the cursor left or right by pressing the TRACK+ or TRACK- buttons, respectively, on the remote control.

- 4 Press the DISC+ or DISC- button to display the desired character.
Besides the alphabet (capital letters only) and numbers, you can choose the following characters: /, +, -, *, =, <, >, [and].

NOTE Direct Alphabet Input

If the disc changers that were manufactured and sold after 1997 (except for KDC-C560) are connected, you can directly input letters using the number/letter entry buttons on the remote. Example: Use the following table to enter the name "DANCE".

Character	Button to press	# Times pressed
"D"	#3	1
"A"	#2	1
"N"	#6	2
"C"	#2	3
"E"	#3	2

- 5 Continue steps 3 and 4 until all the characters are chosen for the name.
- 6 Press either the NAME.S button on the main unit or the OK button on the remote.
The disc name is stored and the disc name preset mode is canceled.
If you make no entry in a 10-second period, the name will be stored with the characters input so far.

NOTE

- The number of characters and discs whose names can be stored will differ depending on the disc changer that is connected. Please see your disc changer manual for details. Up to 12 characters and 100 CDs can be registered with this unit.
- Discs are identified by their total length and number of tracks. If another disc happens to have the same specifications as one that you have already stored a name for, the name will be displayed for it, too.
- If you want to change the name of a disc, repeat steps 1 and 2 to display the name, and then repeat steps 3 and 4 to input the changes.
- Pressing the reset button erases the disc names stored in this unit, but does not erase names stored in a disc changer.

Disc control features *(See page 9)*

Function of remote with number/letter entry buttons (See page 10)

Direct Track Search

Using the remote, directly input the track number that you want to listen to.

- 1 Using the number buttons on the remote, input the number of the track that you want to listen to.
The selected track number will blink in the display for 10 seconds.
If you make no further input in the 10-second period, the number entry mode will automatically be canceled.
- 2 Press either the TRACK+ or TRACK- button while the track number is blinking.
The track starts playing.

Canceling Direct Track Search While It Is Operating:

Press the ►|| button.

NOTE

You cannot use the direct track search function while doing track or disc scans or using random or magazine-random play.

Function of disc changers with remote having number/letter entry buttons (See page 10)

Direct Disc Search

Using the remote, directly input the disc number that you want to listen to.

- 1 Using the number buttons on the remote, input the number of the disc that you want to listen to.
The selected disc number will blink in the display for 10 seconds.
If you make no further input in the 10-second period, the number entry mode will automatically be canceled.

NOTE

- Input "0" to select disc 10.
- If you input more than two numbers all at once, a search will be made only of the last number input.

- 2 Press either the DISC+ or DISC- button while the number inputted is blinking.
The disc starts playing.

Canceling Direct Disc Search While It Is Operating:

Press the ►|| button.

Function of remote with DNPP button (See page 10)

Disc Name Preset Play (DNPP)

If you have preset the name of a disc that you want to listen to in the disc changer, you can look for it by name and start playing it.

- 1 Press the DNPP button on the remote.
"DNP PLAY" will appear in the display, and the disc name preset play mode is entered.
The names of all the discs in the disc changer will appear successively in the display for five seconds each.
Discs whose names have not been preset will appear as "NO NAME" in the display.

NOTE

- This function can only be used in disc changers that were manufactured or sold as of 1997. Also note that some units cannot provide a display unless the disc name preset has been made by the unit that is playing.
- Discs in the disc changer that have never been played before will appear as "NO ACCESS" when the disc names are displayed. When you cannot identify a disc because of the "NO ACCESS" display after inserting a disc magazine, try playing it using the disc scan or a similar function to display the disc name.

Rapid display (forward / reverse):

Press the DISC+ or DISC- button.

Pressing the DISC+ button will rapidly display the preset names/disc titles in order.

Pressing the DISC- button will rapidly display the preset names/disc titles in reverse order.

2 When the name appears for the disc you want to play

Press the OK button.

The disc whose name is displayed will be recalled, and the disc name preset play (DNPP) mode will end.

To cancel DNPP mode:

Press the DNPP button.

The disc name preset play (DNPP) mode will be canceled.

Other features (See page 10)

Audio Control Setting

Adjust various parameters of sound quality.

1 Press the AUD button to enter the control mode.

2 Press either the FM or AM button.

Each time the button is pressed, the adjustment mode will change as follows:

Pressing the FM button advances the display, and pressing the AM button reverses it.

• When preout is switched to unbalanced

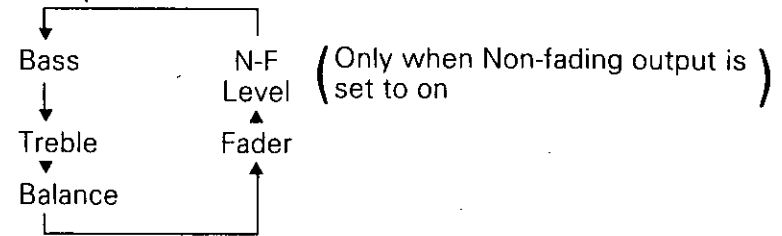

• When preout is switched to balanced

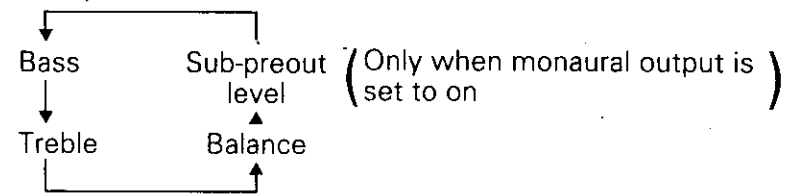

NOTE Source tone memory

Each source (CD, FM, AM and disc changer) has its own memory in which to store the bass and treble tone settings.

The settings made for a particular source are recalled automatically whenever you use that source (for example, FM mode uses the tone settings made for FM, AM for AM, etc.).

3 Press the ◀◀/▶▶ button.

Look at the table (See page 28) to adjust the mode being displayed.

4 Press the AUD button to end the control mode.

Other features (See page 10)

Table of Audio Control Setting

Adjustment mode (Display)	Operation of Audio control button	
	◀◀ button	▶▶ button
Bass ("BAS")	Bass decreased.	Bass increased.
Treble ("TRE")	Treble decreased.	Treble increased.
Balance ("BAL")	Left channel emphasized.	Right channel emphasized.
Fader ("FAD")	Rear channel increased.	Front channel increased.
Non-Fading Preout Level ("NF")	Non-fading sound is reduced.	Non-fading sound emphasized.
Balanced monaural preout level ("SUB")	Monaural sound is reduced.	Monaural sound emphasized.

Balanced Output

You can change preouts to balanced outputs, which allows you to reduce noise if the amplifier being connected has balanced input. The factory default is unbalanced output. The balanced monaural sound output can be set to either ON or OFF. The non-fading sound output can be set to either ON or OFF. The factory default is set to ON.

Switching balanced / unbalanced output:

- 1 Press the MENU button for at least one second. "MENU" is displayed and the menu mode is turned on.
- 2 Keep pressing the ▶▶ button until the Balanced output function appears in the display. Press the ◀◀ button to search in the other direction. The function setting is indicated by "UNBALANCED" or "BALANCED" in the display, indicating that the current output is balanced or unbalanced, respectively. "UNBALANCED" (Unbalanced output) "BALANCED" (Balanced output)
The front/rear output corresponds to the L/R channels during balanced output. The non-fading preout will change to monaural (mono) sounds during balanced output.

	UNBALANCED	BALANCED
FRONT	Left Right	Left ⊖ Right ⊖
REAR	Left Right	Left ⊕ Right ⊕
NON-FADING	Left Right	Monaural ⊕ Monaural ⊖

3 Switching settings

Press either the AM or FM button. The display and setting will change.

- 4 Press the MENU button to end the menu mode.

NOTE

- The audio control and volume return to factory default settings each time you switch between balanced and unbalanced output.

- The non-fading output/ balanced monaural output setting turns ON each time you switch the output between balanced and unbalanced.
- The attenuator function turns off when you switch the output between balanced and unbalanced while the attenuator is on.

Turning monaural output On/Off: (during balanced output)

Press the NF button for at least one second to set the function ON or OFF.

"SUB ON" is displayed when the monaural output is set ON.

Turning non-fading output On/Off: (during unbalanced output)

Press the NF button for at least one second to set the function ON or OFF.

"NF ON" is displayed when the non-fading output is set ON.

Dimmer

You can dim the display.

Turning Dimmer On/Off:

Press the DIMMER button for at least one second to switch dimmer on and off.

Selectable Illumination

You can switch the setting of the button illumination between green and amber, or turn the illumination off.

- 1 Press the MENU button for at least one second.
"MENU" is displayed and the menu mode is turned on.
- 2 Keep pressing the ►► button until the Selectable Illumination function appears in the display.
Press the ◄◄ button to search in the other direction.
The function setting is indicated by "COLOR GREEN" or "COLOR AMBER" or "ILLUMI OFF" in the display, indicating that the current color is green or amber, or illumination is off, respectively.

3 Switching settings

Press either the AM button or FM button.
The display and setting will change.

- 4 Press the MENU button to end the menu mode.

NOTE

When making audio adjustments or operating menu mode, even when this function is set to "ILLUMI OFF", the illumination is not turning off.

Touch Sensor Tone

This function produces a beep sound that accompanies button operation. It can be switched on or off.

Switching the Beep On/Off:

- 1 Press the MENU button for at least one second.
"MENU" is displayed and the menu mode is turned on.
- 2 Keep pressing the ►► button until the Touch Sensor Tone function appears in the display.
Press the ◄◄ button to search in the other direction.
The function setting is indicated by "BEEP ON" or "BEEP OFF" in the display, indicating that the current beep setting is on or off, respectively.
- 3 **Switching settings**
Press either the AM or FM button.
The display and setting will change.
- 4 Press the MENU button to end the menu mode.

NOTE

The beep sound is not output from the preout jacks.

Other features (See page 10)

Switching Clock Display

This function permits switching the clock display on/off when switching the display during each of the modes.

Turning the Clock display On/Off:

- 1 Press the MENU button for at least one second.
"MENU" is displayed and the menu mode is turned on.
- 2 Keep pressing the ►► button until the Switching Clock Display function appears in the display.
Press the ◄◄ button to search in the other direction.
The function setting is indicated by "CLOCK ON" or "CLOCK OFF" in the display, indicating that the the Clock display function is on or off, respectively.
- 3 **Switching settings**
Press either the AM or FM button.
The display and setting will change.
- 4 Press the MENU button to end the menu mode.

Switching Graphic Display

This function permits the graphic display to be switched to one that is linked with the volume level value or to display various modes. The initial setting is ON (displaying various modes).

Turning the Graphic Display On/Off:

- 1 Press the MENU button for at least one second.
"MENU" is displayed and the menu mode is turned on.
- 2 Keep pressing the ►► button until the Switching Graphic Display function appears in the display.
Press the ◄◄ button to search in the other direction.
The function setting is indicated by "GRAPHIC ON" or "GRAPHIC OFF" in the display, indicating that the Graphic display is on or off, respectively.
"GRAPHIC ON" (Displays various modes)
"GRAPHIC OFF" (Display linked to the volume level value)
- 3 **Switching settings**
Press either the AM or FM button.
The display and setting will change.
- 4 Press the MENU button to end the menu mode.

NOTE

When making audio adjustments, even when this function is on, the display will be linked to the audio adjustment value, not the display of the various modes.

Adjusting Time

You can adjust the time manually. Also, with the automatic time adjustment function set at ON, you can set the clock time automatically according to time data sent from RBDS stations after receiving RBDS signals for several minutes). The factory default is manual time adjustment.

Adjusting Time Manually:

- 1 Press the MENU button for at least one second. "MENU" is displayed and the menu mode is turned on.
- 2 Keep pressing the ►► button until the "CLOCK ADJUST" appears in the display. Press the ◀◀ button to search in the other direction.
- 3 Press either the AM or FM button for at least two seconds to enter the Time Adjustment mode. The hour display will blink.
- 4
 - Adjusting the hours
Press the FM button to advance the hours, or press the AM button to make the hours go back.
 - Adjusting the minutes
Press the ►► button to advance the minutes, or press the ◀◀ button to make the minutes go back.
- 5 Press the MENU button to end the menu mode.

NOTE

Manual adjustment is effective only when the automatic adjustment is off.

Turning Automatic Time Adjustment On/Off:

- 1 Press the MENU button for at least one second. "MENU" is displayed and the menu mode is turned on.
- 2 Keep pressing the ►► button until the Automatic Time Adjustment function appears in the display. Press the ◀◀ button to search in the other direction. The function setting is indicated by "SYNC ON" or "SYNC OFF" in the display, indicating that the Automatic Time Adjustment is on or off, respectively.
"SYNC ON" (Automatic time adjustment)
"SYNC OFF" (Manual time adjustment)

3 Switching settings

Press either the AM or FM button. The display and setting will change.

- 4 Press the MENU button to end the menu mode.

Adjusting Time Automatically:

Tune to a RBDS station and receive the signal for several minutes.

The clock will adjust automatically to the local time.

NOTE

The clock will not adjust automatically if the RBDS station tuned to is not transmitting time data. In such a case, try another RBDS station.

Other features (See page 10)

Security Code

When the battery is removed from the unit's power switch, you cannot turn on the unit again unless the preset security code is input. This function helps prevent theft.

NOTE

You must follow steps 1 to 8 to be able to use the Security Code function. Turning off the power during the procedure will deactivate the security code setting.

Once the security code function has been activated, "SECURITY" disappears from the MENU system. Note that it will no longer be possible to cancel this function afterwards.

- 1 Select the four digits to use in your security code.

NOTE

The four-digit security code is very important, as you will need it to turn the unit on again when the security code function is on. Choose the number carefully and do not forget it (write it down and keep it separately in a safe place).

- 2 Press the MENU button for at least one second.
"MENU" is displayed and the menu mode is turned on.
- 3 Keep pressing the ►► button until "SECURITY" appears in the display.
Press the ◄◄ button to search in the other direction.
- 4 Press either the AM or FM button for at least two seconds.
"ENTER" will appear in the display for one second, indicating the code setting mode has been entered. When "CODE" appears in the display, you can start inputting the code.
- 5 Press the preset button and enter the security code that you have selected in step 1.

Example: Use "3510" as the security code.

Step	Button to press	# Times pressed	Display
1	#1	4	"3"
2	#2	6	"5"
3	#3	2	"1"
4	#4	1	"0"

- 6 Press the DISP button for at least three seconds.
The security code will be set.
"RE-ENTER" will appear in the display for one second, asking you to enter the code once again for confirmation. When "CODE" appears in the display, you can start inputting the code.
- 7 Press the Preset button and input the security code again.
- 8 Press the DISP button again for at least three seconds.
"APPROVED" will appear in the display, with the security code function turning on. From this point on, if the unit is disconnected from the battery, the security code must be entered the first time that the unit's power is turned on.
"ENTER" and "CODE" will appear in the display, asking you to input the code.

NOTE

If you input an incorrect security code, the display ask you once more to input the correct one. Follow the procedure in step 7 above.

If you press the RESET button or remove the battery:

The first time you turn the unit on again, "CODE" will appear in the display, asking you to input the security code.
Repeat steps 7 and 8 above, and input the security code.
You can start operating the unit again when "APPROVED" appears in the display.
If you enter the incorrect code, the power will turn off. Enter the correct code to turn the unit on.

Basic operations of remote (See page 10)

▲CAUTION

Do not set the remote on hot places such as above the dashboard.

Replacing the Lithium Battery:

Use one lithium battery (CR2025).

Remove the case following the instructions as illustrated.

To open

① Keep on slide

② Pull out.

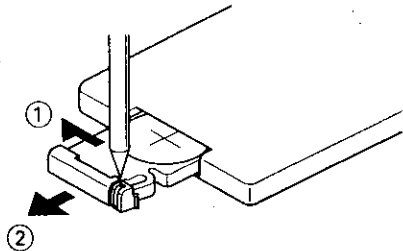

Insert the battery with the + and - poles aligned properly, following the illustration inside the case.

▲WARNING

Store unused lithium batteries out of the reach of children. Contact a doctor immediately if the battery is accidentally swallowed.

NOTE

A portion of the operations may not be possible, depending on the unit that is connected.

All Modes

- **VOL. buttons**
Press the \wedge button to turn the volume up.
Press the \vee button to turn the volume down.
- **TUNER button**
Selects the tuner mode.
- **CD button**
Selects the CD mode.
- **CD•MD CH button**
Selects the disc control mode.

NOTE

The disc control mode will differ depending on the unit that is connected.

Basic operations of remote (See page 10)

Tuner Mode

- **Number/ letter entry buttons**
Press buttons #1-6 to recall preset stations.
During direct access tuning, use these buttons to input the frequency of the station.
Use to enter letters (alphabetical) during station name preset.
- **TUNE buttons**
Press the ◀◀ button to make decreasing seeks (using the preset tuning mode).
Press the ▶▶ button to make increasing seeks (using the preset tuning mode).
Use to move the cursor left or right during station name input.
- **AM/FM button**
Press the AM button to select the AM band.
Press the FM button to select and switch between FM1, FM2, and FM3 bands.
During station name input, selects digits and symbols.
- **DIRECT/OK button**
Selects the direct access tuning mode, used to input frequencies directly. Press this button again to cancel the mode while it is operating.
During station name input, stores the already input data in memory and ends the input mode.
During Station name preset play mode, selects station.
- **DNPP button**
Enters and cancels the Station Name Preset Play mode.

Disc Control Mode

- **Number/ letter entry buttons**
Used to specify the track (disc) number used in direct track (disc) searches.
Use to enter letters during disc name preset.
- **TRACK buttons**
Press the TRACK- button to search through the tracks backward.
Press the TRACK+ button to search through the tracks forward.
Use to move the cursor while entering disc name.
- **DISC buttons**
Press the DISC- button to search through the discs backward.
Press the DISC+ button to search through the discs forward.
Select numbers and symbols while entering disc name.
- **▶|| button**
When a disc is playing, this button pauses the play.
Press the same button again to start play again.
- **OK button**
During disc name input, stores the already input data in memory and ends the input mode.
Selects disc during the disc name preset play mode.
- **DNPP button**
Enters and cancels the Disc Name Preset Play mode.

Accessories

External view

..... Number of items

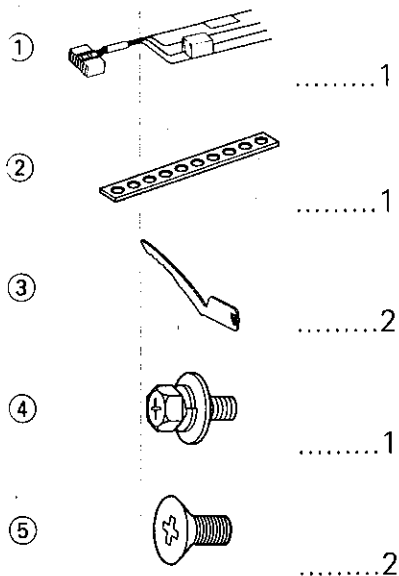

▲CAUTION

Do not use any accessories other than those provided with your unit. If you use other accessories, you may damage the unit.

External view

..... Number of items

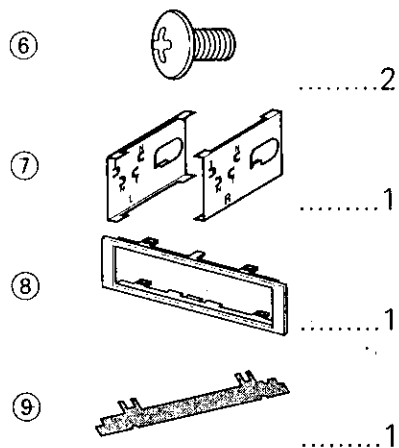

- Press "the touch-sensitive spot" at the rear of the faceplate (see p.11) to make the faceplate control panel appear. Then press the Reset button.

▲CAUTION

- If your car's ignition does not have an ACC position, connect the ignition wires to a power source that can be turned on and off with the ignition key. If you connect the ignition wire to a power source with a constant voltage supply, as with battery wires, the battery may die.
- If the console has a lid, make sure to install the unit so that the faceplate will not hit the lid when closing and opening.
- If the fuse blows, first make sure the wires aren't touching to cause a short circuit, then replace the old fuse with one with the same rating.
- Do not let unconnected wires or terminals touch metal on the car or anything else conducting electricity. To prevent a short circuit, do not remove the caps on the ends of the unconnected wires or the terminals.
- After the unit is installed, check whether the brake lamps, blinkers, wipers, etc. on the car are working properly.
- Insulate unconnected wires with vinyl tape or other similar material.
- Some disc changers need conversion cords for connection. See the section on "Safety Precautions" for details.
- Mount the unit so that the mounting angle is 30° or less.

Installation Procedure

- To prevent a short circuit, remove the key from the ignition and disconnect the ⊖ battery.
- Make the proper input and output wire connections for each unit.
- Connect the wiring harness wires in the following order: ground, battery, ignition.
- Connect the wiring harness connector to the unit.
- Install the unit in your car.
- Reconnect the ⊖ battery.

Connecting Wires to Terminals

UNBALANCED		BALANCED
FRONT	Left	Left ⊖
	Right	Right ⊖
REAR	Left	Left ⊕
	Right	Right ⊕
NON-FADING	Left	Monaural ⊕
	Right	Monaural ⊖

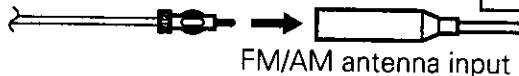
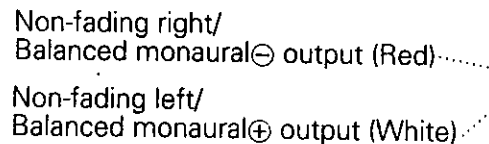
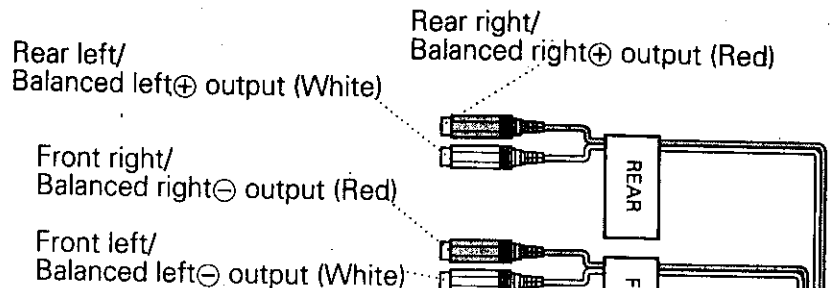

NOTE
To connect the Disc changer, consult your Disc changer manual.

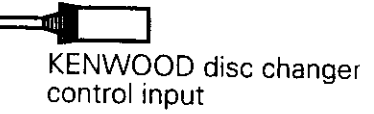

Fuse

Wiring harness (Accessory①)

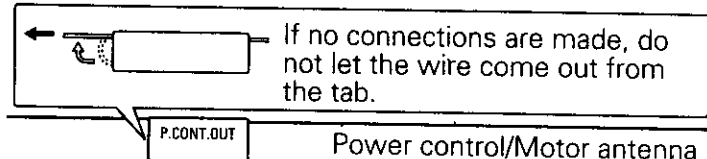

Power control/Motor antenna control wire (Blue/White)

Connect either to the power control terminal when using the optional power amplifier, or to the antenna control terminal in the vehicle.

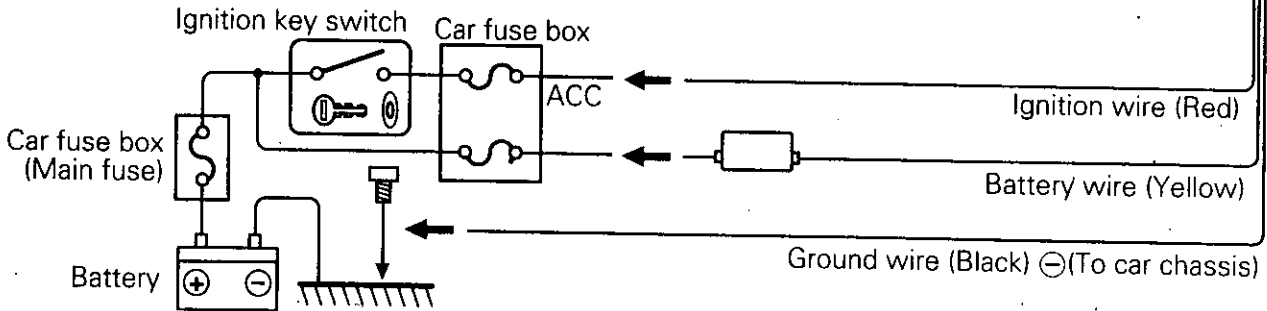

⚠WARNING

If you connect the ignition wire (red) and the battery wire (yellow) to the car chassis (ground), you may cause a short circuit, that in turn may start a fire. Always connect those wires to the power source running through the fuse box.

Installation (non-Japanese cars)

■ Installation (non-Japanese cars)

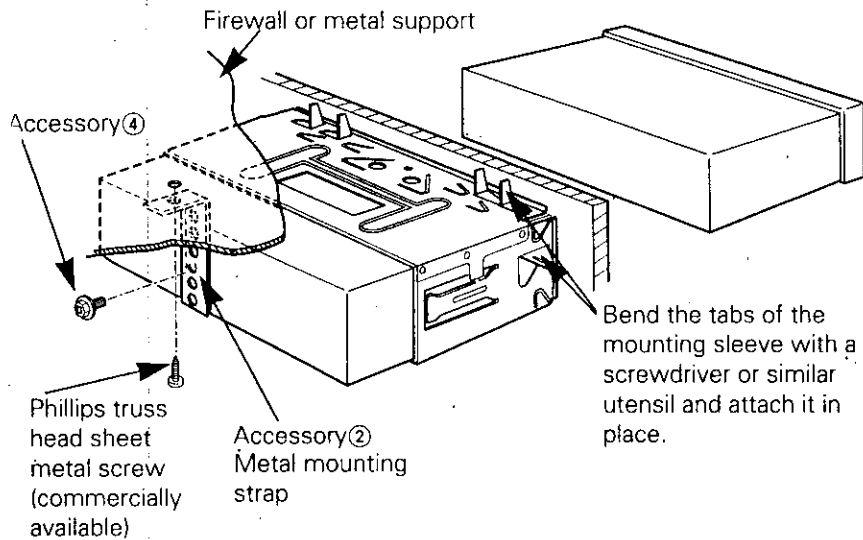

NOTE

Make sure that the unit is installed securely in place. If the unit is unstable, it may malfunction (for example, the sound may skip).

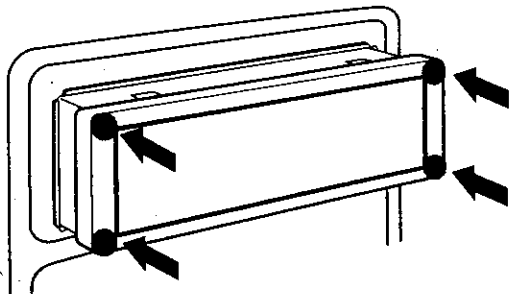

CAUTION

To attach this unit, fit it into the mounting sleeve by pressing the four corners of the hard rubber frame.
Do not apply strong pressure to other sections than the corners; otherwise troubles such as the impossibility of opening or closing the panel may result.

Removing the Unit

■ Removing the hard rubber frame

- 1 Insert the removal tool⑨ deeply with the cut placed to the right to remove the upper locks at an angle as shown below.

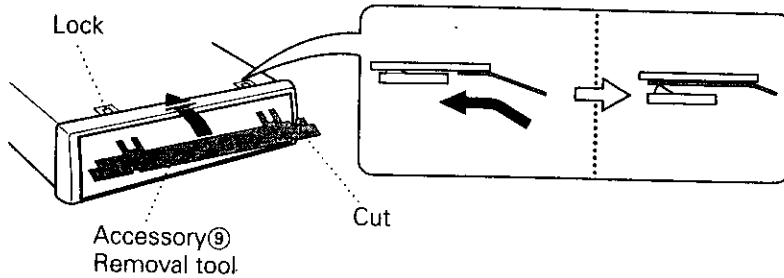

- 2 Engage the catches on the removal tool③ and remove the two locks on the lower level, leaving the removal tool⑨ inserted on the upper level.
Lower the frame and pull it forward as shown in the figure.

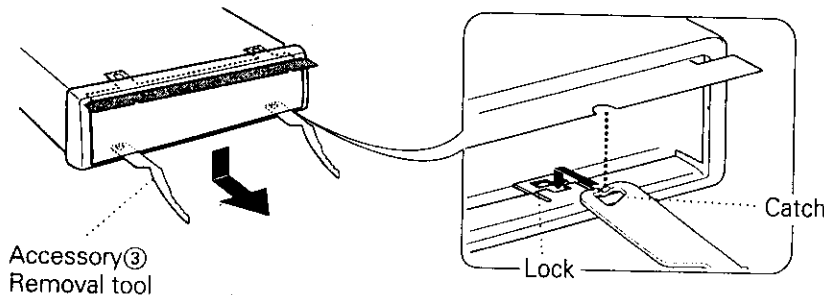

NOTE

You will feel (not hear) a click when the tabs lock securely.

■ Removing the Unit

- 1 Refer to the section "Removing the hard rubber frame" and then remove the hard rubber frame.
- 2 Remove the hex head machine screw with washer (M4x8) on the back panel.
- 3 Insert the two removal tools at an angle and push them deeply into the slots on each side, as shown.

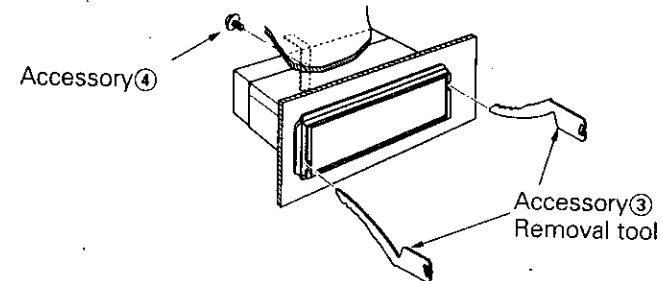

- 4 Push downward on the left-hand tool and the upward on the right-hand tool, as shown, and pull the unit toward you until it is halfway out. The unit may drop if you pull it out completely.

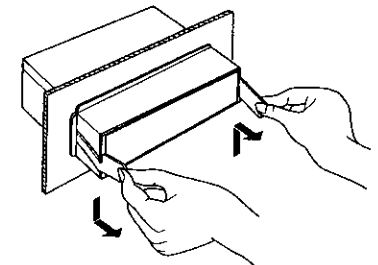

CAUTION

Be careful to avoid injury from the catch pins on the removal tool.

- 5 Pull the unit all the way out with your hands, being careful not to drop it.

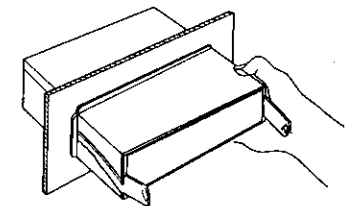

Installation (Japanese-cars)

■ Installing Radio Bracket in Japanese-made Cars (J-Cars)

On the factory-installed radio bracket, flatten all the tabs or holes that are not flush (except those used for screws), using a hammer or similar utensil.

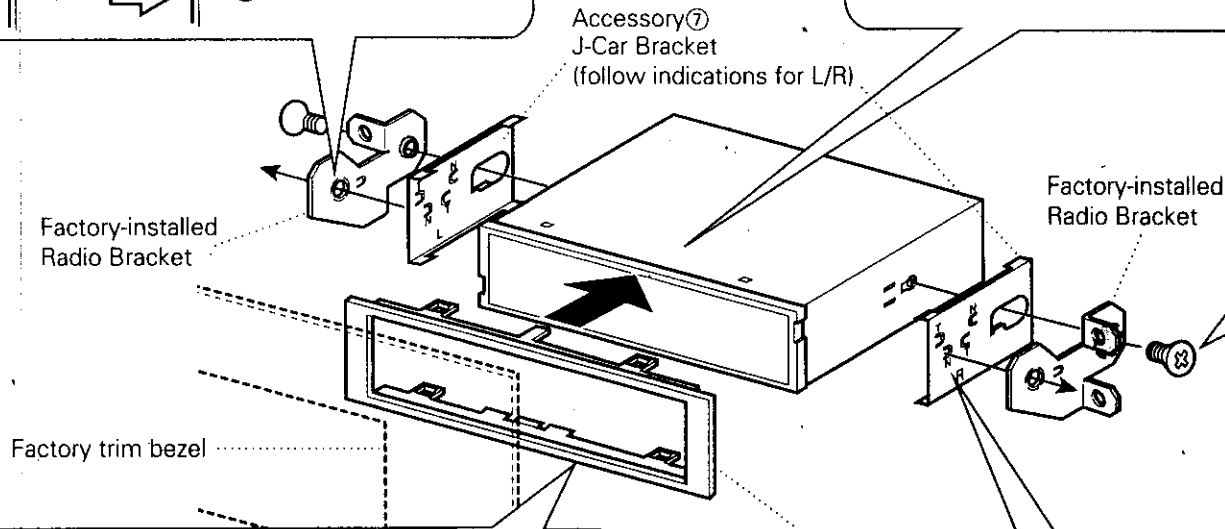
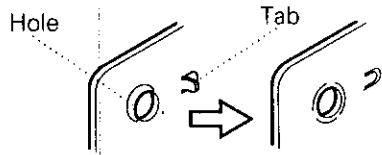

After aligning the J-Car bracket with the factory-installed radio bracket, tighten the screws.

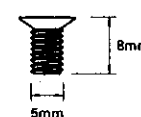

Accessory ⑤
for Nissan car

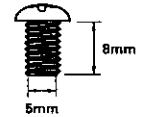

Accessory ⑥
for Toyota car

▲CAUTION

Damage to the unit will result from using screws other than those provided.

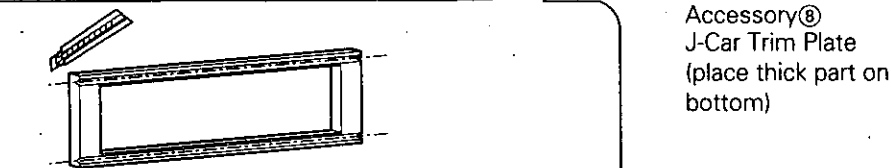

Accessory ⑧
J-Car Trim Plate
(place thick part on
bottom)

Once you have affixed the factory-installed radio bracket with the screws, use a standard-tipped screwdriver (not Philips) or similar utensil to pry the tabs of the J-Car bracket to make them fit into the holes in the factory-installed radio bracket (depending on the car make).

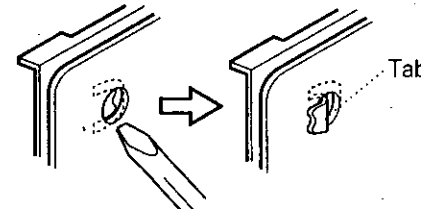

N ... Nissan car
T ... Toyota car

Installing in Toyota cars

If necessary, neatly cut the frame of the trim plate with an engraving knife or similar utensil, following the inner grooves on the top and bottom of the plate.

NOTE

You may have to cut the factory trim bezel as well if it interferes with the movement of the face plate.

Troubleshooting Guide

What might seem to be a malfunction in your unit may just be the result of slight misoperation or miswiring. Before calling service, first check the following table for possible problems.

PROBLEM	POSSIBLE CAUSE	SOLUTION
The power does not turn on.	The fuse has blown.	After checking for short circuits in the wires, replace the fuse with one with the same rating.
No sound can be heard, or the volume is low.	Attenuator is turned on.	Turn off Attenuator.
	The fader or balance settings are set all the way to one side.	Reset the fader or balance settings.
	The input/output wires or wiring harness are connected incorrectly.	Reconnect the input/output wires or the wiring harness correctly. See the section on "Connecting Wires to Terminals".
	The unbalanced/balanced setting of preouts have not corresponded with the setting of your amplifier.	Check both the settings.
Nothing happens when the buttons are pressed.	The computer chip in the unit is not functioning normally.	Press the reset button on the unit (see p.6).
The sound quality is poor or distorted.	One of the speaker wires is being pinched by a screw in the car.	Check the speaker wiring.
	The speakers are not wired correctly.	Reconnect the speaker wires so that each output terminal is connected to a different speaker.
Radio reception is poor.	The car antenna is not extended.	Pull the antenna out all the way.
	The antenna control wire is not connected.	Connect the wire correctly, referring to the section on "Connecting Wires to Terminals".
The memory is erased when the ignition is turned off.	The battery wire has not been connected to the proper terminal.	Connect the wire correctly, referring to the section on "Connecting Wires to Terminals".
	The ignition and battery wire are incorrectly connected.	Connect the wire correctly, referring to the section on "Connecting Wires to Terminals".

PROBLEM	POSSIBLE CAUSE	SOLUTION
A CD ejects as soon as it is loaded.	The CD is upside-down.	Load the CD with the labeled side up.
	The CD is quite dirty.	Clean the CD, referring to the section on "Cleaning CDs" (see p. 7).
The sound skips on a CD.	The CD is scratched or dirty.	Clean the CD, referring to the section on "Cleaning CDs" (see p. 7).
A track will not play.	Random play has been selected.	Turn off random play.

Disc Control Mode

PROBLEM	POSSIBLE CAUSE	SOLUTION
The disc control mode cannot be selected.	No cable has been connected to the disc changer input terminal on the unit.	Connect the cable to the disc changer input terminal on the unit.
	The O-N selection switch of the disc changer is not set properly.	Set the O-N selection switch to "O" position.
The specified disc does not play, but another one plays instead.	The specified CD is quite dirty.	Clean the CD.
	The CD is upside-down.	Load the CD with the labeled side up.
	The disc is loaded in a different slot from that specified.	Eject the disc magazine and check the number for the specified disc.
	The disc is severely scratched.	Try another disc instead.
The sound skips.	Something is touching the disc changer.	Remove whatever is touching it.
	The CD is scratched or dirty.	If skipping happens at the same place when the car is stopped, something with the CD is wrong. Clean the CD.
The display shows that the changer is being played, but no sound can be heard.	The computer chip in the unit is not functioning normally.	Press the reset button on the unit (see p. 6).
The specified track will not play.	Random play or magazine random play has been selected.	Turn off random play or magazine random play.

Troubleshooting Guide

The following messages are displayed when certain problems are occurring in your system. Take the recommended actions.

- EJECT** No disc magazine has been loaded in the changer. The disc magazine is not completely loaded.
⇒ Load the disc magazine properly.
- NO DISC** No disc has been loaded in the disc magazine.
⇒ Load a disc into the disc magazine.
- E-04** No disc has been loaded in the disc magazine.
⇒ Load a disc into the disc magazine.
The CD is quite dirty. The CD is upside-down. The CD is scratched a lot.
⇒ Clean the CD and load it correctly.
- BLANK** Nothing has been recorded on the MD.
⇒ The next MD will automatically be played.
- NO TRACK** No tracks are recorded on the MD, although it has a title.
⇒ The next MD will automatically be played.
- E-77** The unit is malfunctioning for some reason.
⇒ Press the reset button on the unit. If the "E- 77" code does not disappear, consult your nearest service center.
- E-99** Something is wrong with the disc magazine. Or the unit is malfunctioning for some reason.
⇒ Check the disc magazine. And then, press the reset button on the unit.
If the "E- 99" code does not disappear, consult your nearest service center.
- HOLD** The protective circuit in the unit activates when the temperature inside the automatic disc changer exceeds 60°C (140°F), stopping all operation.
⇒ Cool down the unit by opening the windows or turning on the air conditioner. As the temperature falls below 60°C (140°F), the disc will start playing again.

Specifications

Specifications subject to change without notice.

FM tuner section

Frequency range (200 kHz space)	87.9 MHz – 107.9 MHz
Usable sensitivity (S/N = 30dB)	9.3dBf (0.8 μ V/75 Ω)
Quieting Sensitivity (S/N = 50dB)	15.2dBf (1.6 μ V/75 Ω)
Frequency response (\pm 3.0 dB)	30 Hz – 15 kHz
Signal to Noise ratio (MONO)	75 dB
Selectivity (\pm 400 kHz)	\geq 80 dB
Stereo separation (1 kHz)	40 dB

AM tuner section

Frequency range (10 kHz space)	530 kHz – 1700 kHz
Usable sensitivity (S/N = 20dB)	28 dB μ (25 μ V)

CD player section

Laser diode	GaAlAs (λ =780 nm)
Digital filter (D/A)	8 Times Over Sampling
D/A Converter	1 Bit
Spindle speed	500 – 200 rpm (CLV)
Wow & Flutter	Below Measurable Limit
Frequency response (\pm 1 dB)	10 Hz – 20 kHz
Total harmonic distortion (1 kHz)	0.01 %
Signal to Noise ratio	105 dB (1 kHz)
Dynamic range	100 dB
Channel separation	85 dB

Audio section

Tone action	
Bass:	100 Hz \pm 10 dB
Treble:	10 kHz \pm 10 dB
Preout level / Load (during CD play)	
Unbalanced	4000 mV/10 k Ω
Balanced	8000 mV/10 k Ω
Preout impedance	80 Ω

General

Operating voltage	14.4 V (11 – 16 V allowable)
Current consumption	5.0 A at Rated power
Installation size (W x H x D)	182 x 53 x 162 mm
	7-3/16 x 2-1/16 x 6-3/8 in.
Weight	4.0 Lbs (1.8 kg)